

# FR. INSTRUCTIONS D'ASSEMBLAGE EN. ASSEMBLY INSTRUCTIONS

PT. INSTRUÇÕES DE MONTAGEM  
ES. INSTRUCCIONES DE ENSAMBLAJE  
IT. ISTRUZIONI DI MONTAGGIO  
DE. MONTAGEANLEITUNG  
NL. MONTAGE-INSTRUCTIES

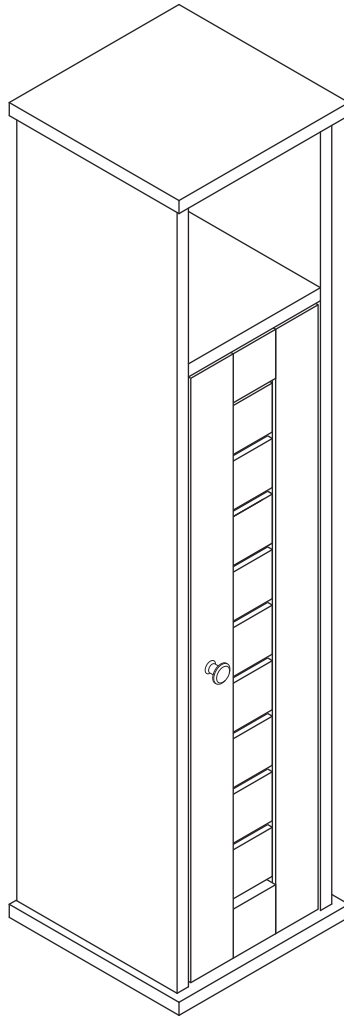

9912-762

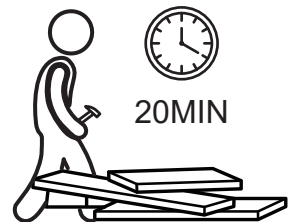
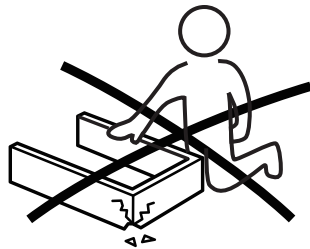
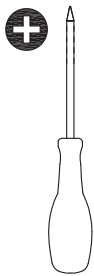

FR. INFORMATIONS À CONSERVER POUR CONSULTATION ULTÉRIEURE - À LIRE ATTENTIVEMENT  
EN. INFORMATION TO BE RETAINED FOR FUTURE REFERENCE - READ CAREFULLY  
PT. INFORMAÇÕES A SEREM MANTIDAS PARA CONSULTA FUTURA - LEIA ATENTAMENTE  
ES. INFORMACIÓN A CONSERVAR PARA CONSULTA FUTURA - LEER ATENTAMENTE  
IT. INFORMAZIONI DA CONSERVARE PER FUTURE CONSULTAZIONI - LEGGERE ATTENTAMENTE  
DE. INFORMATIONEN ZUR SPÄTEREN NACHSCHLAGE - AUFMERKSAM LESEN  
NL. INFORMATIE VOOR LATER BEWAREN - ZORGVULDIG LEZEN









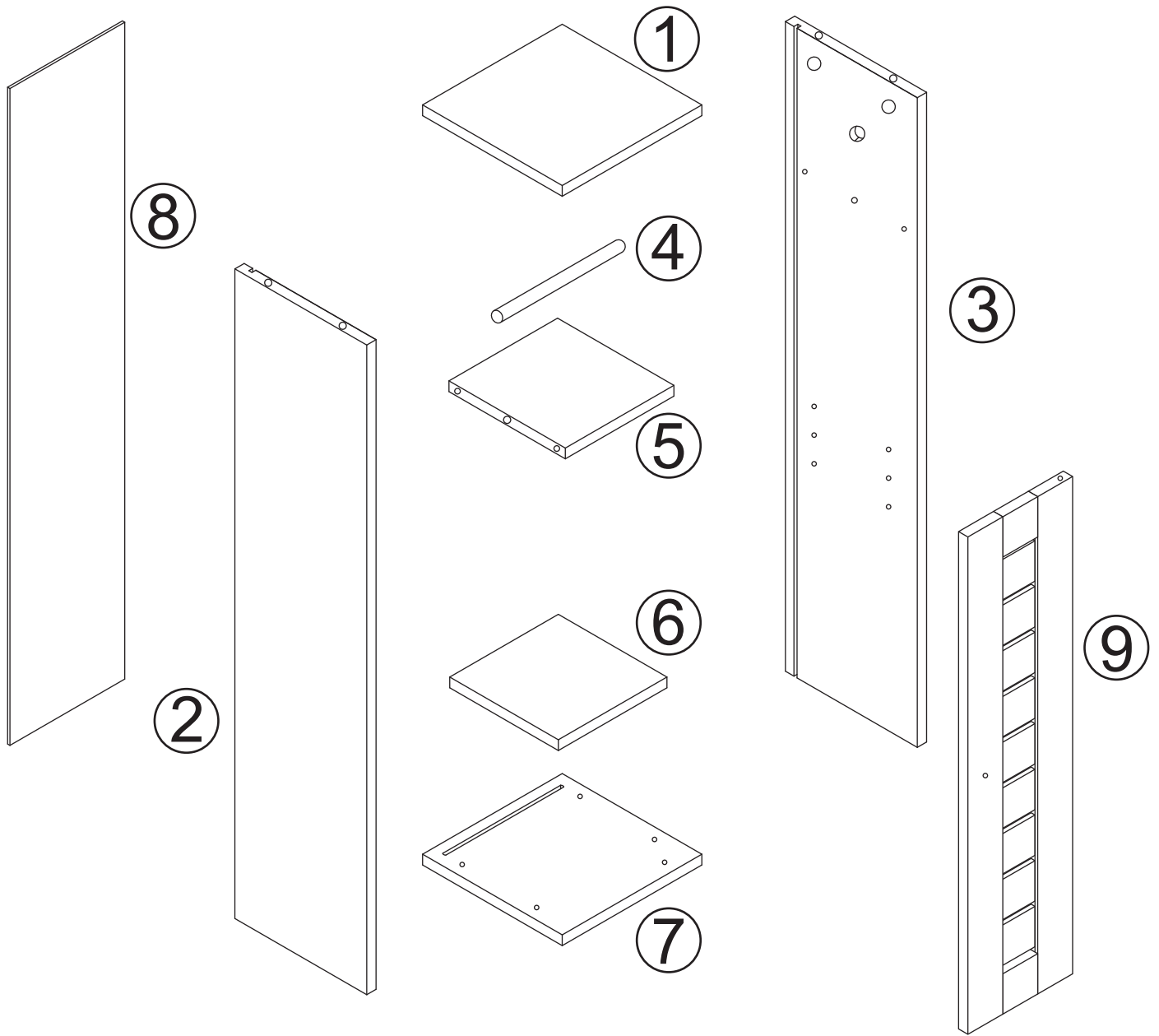

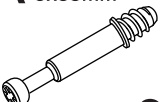

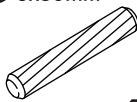
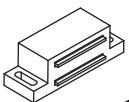

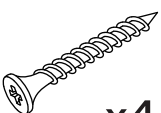

Importé par - Imported by - Importado por  
Importato da - Importiert bei - Geïmporteerd door

**TENDANCE**

27 boulevard des Etines 42120 LE COTEAU - FRANCE  
TVA intracommunautaire N° FR38 500 766 324  
www.tendance-bain.com



<b>A</b> 6x35mm  x6	<b>B</b> 15x10mm  x6	<b>C</b> 6x30mm  x4	<b>D</b>  x1	<b>E</b> 3x14mm  x6	<b>F</b>  x2	<b>G</b> 3x12mm  x1	<b>H</b>  x1
<b>I</b>  x4	<b>J</b> 4x35mm  x4	<b>K</b>  x4	<b>L</b>  x4	<b>M</b>  x4	<b>N</b>  x1	<b>O</b>  x1	2/8

1

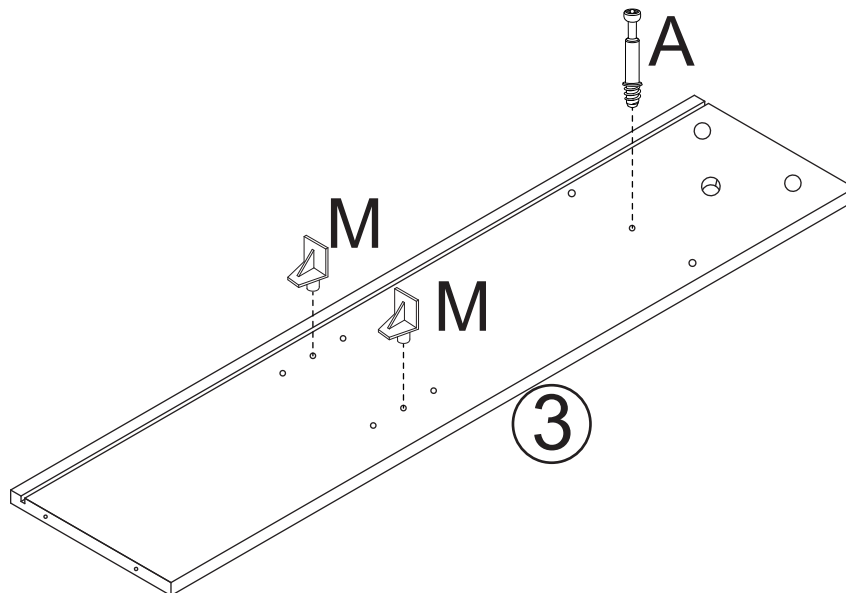
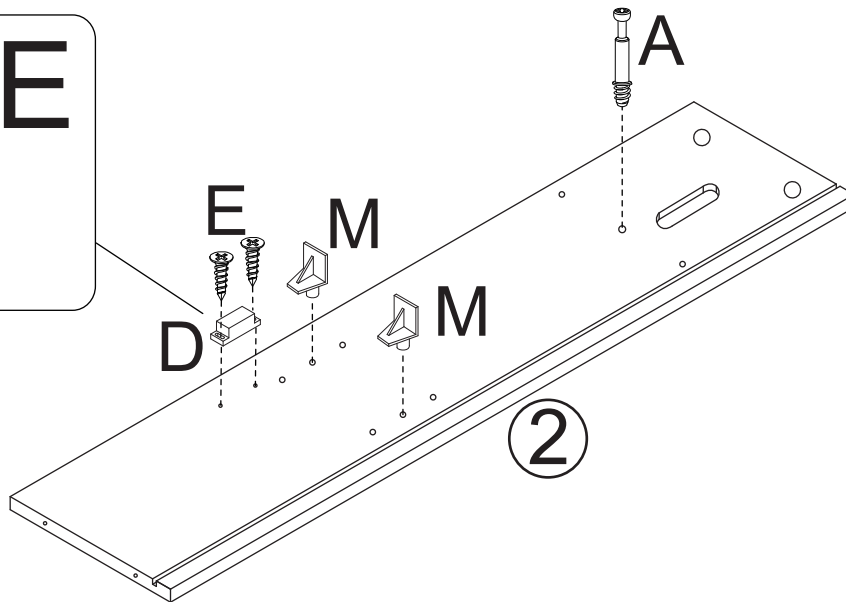
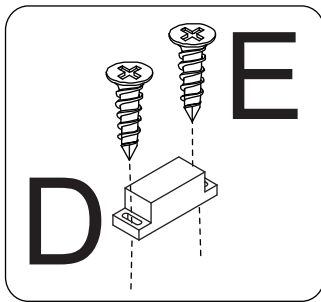
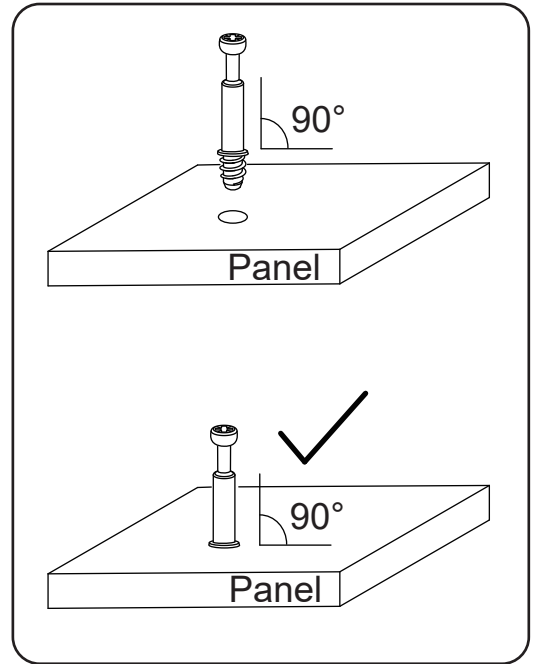
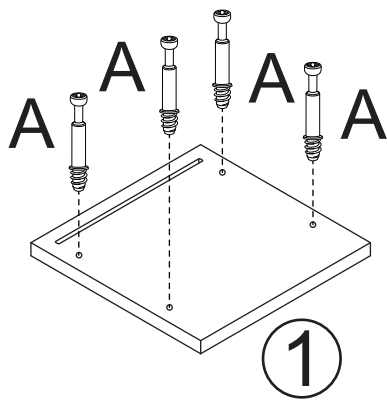

2

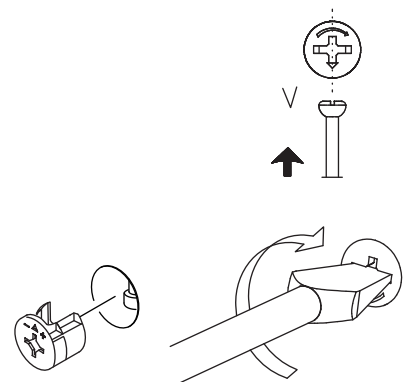
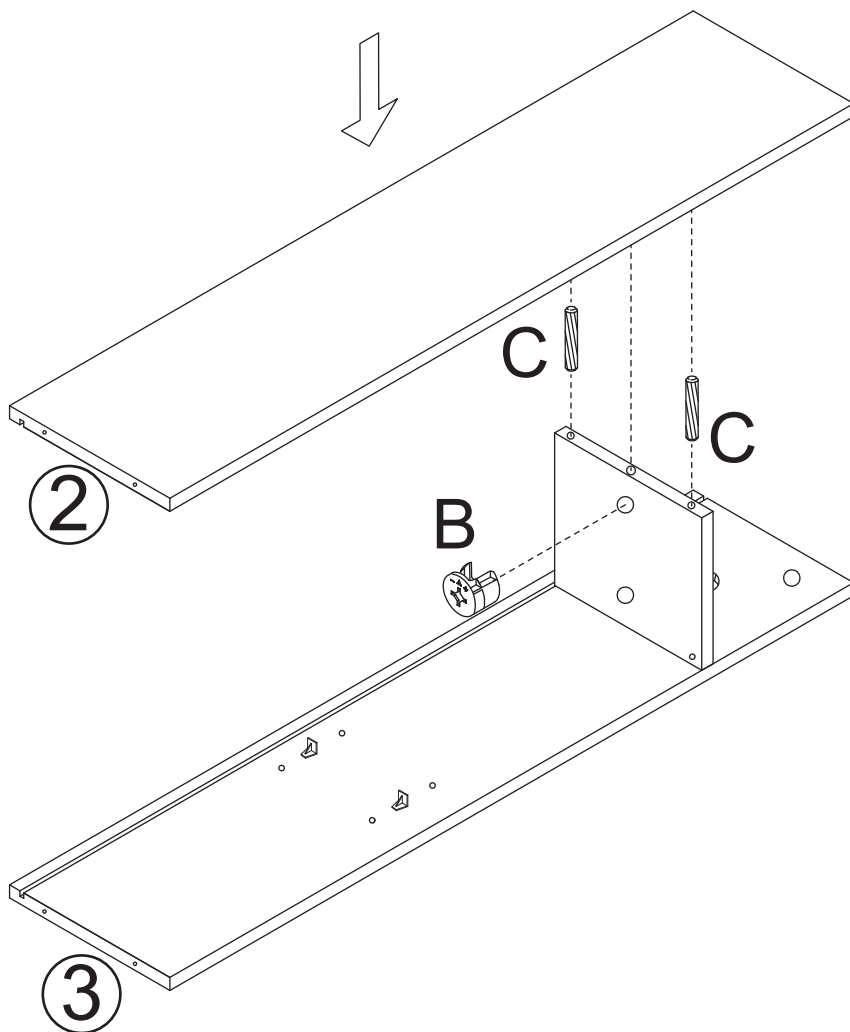
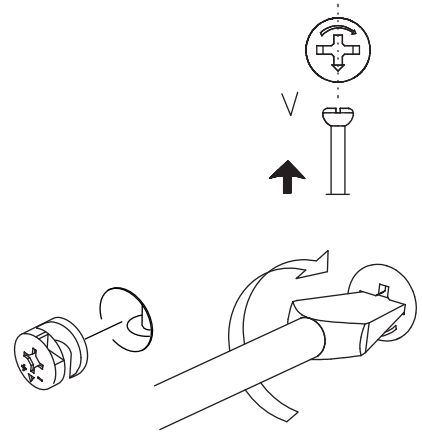
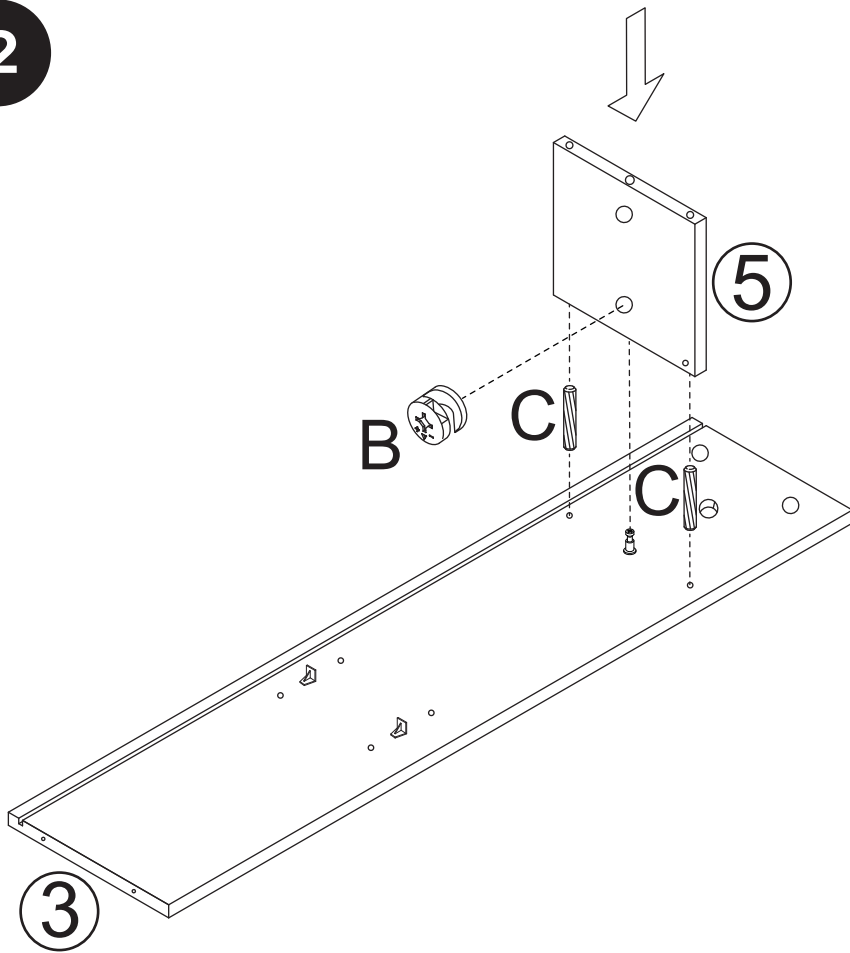

3

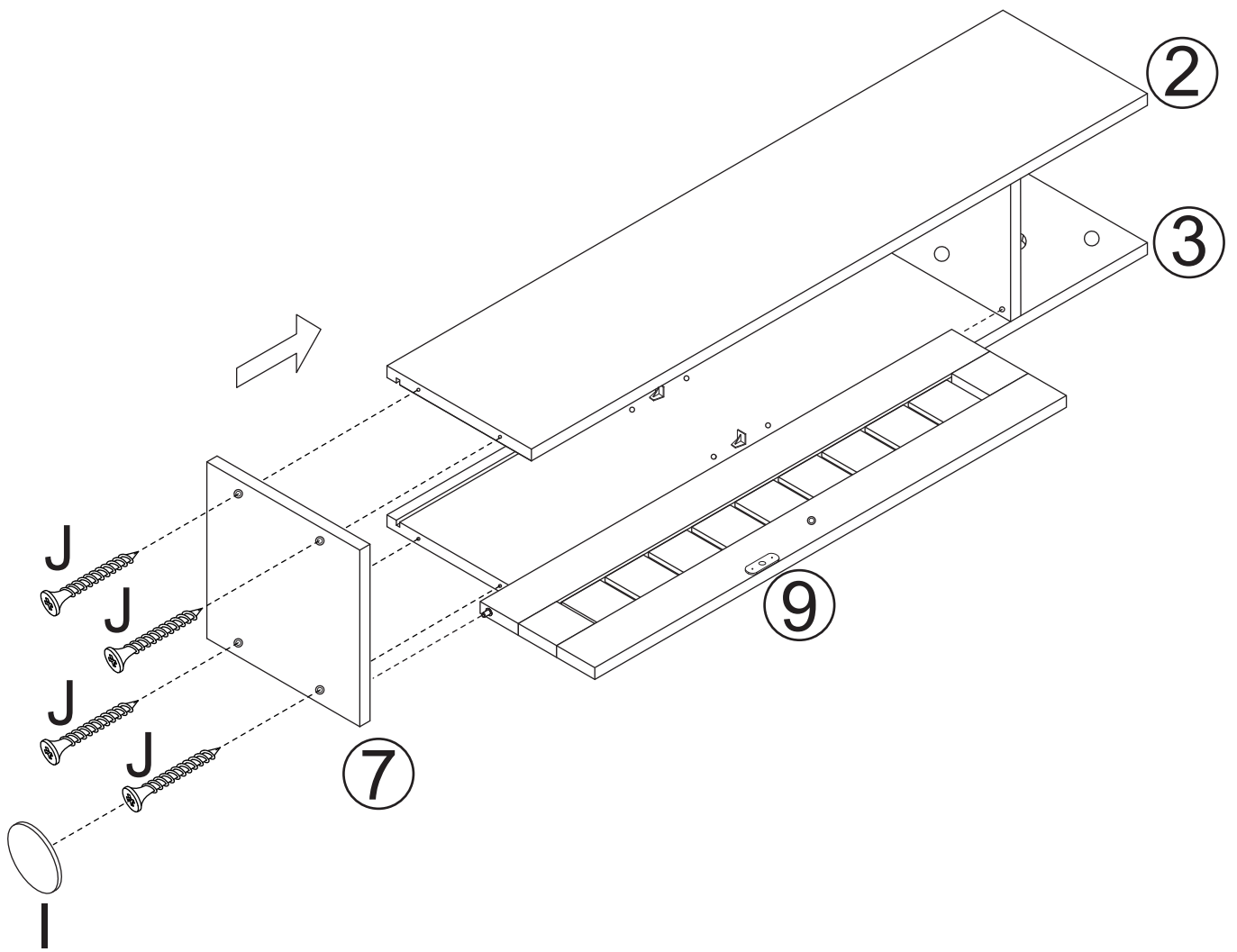
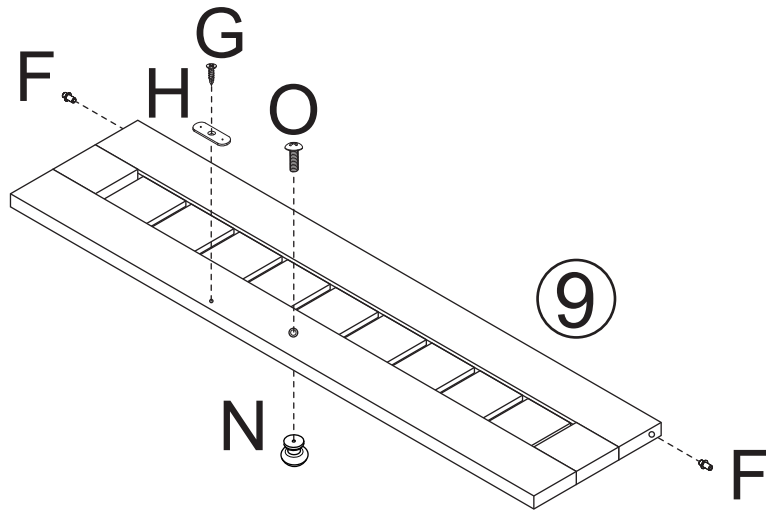

4

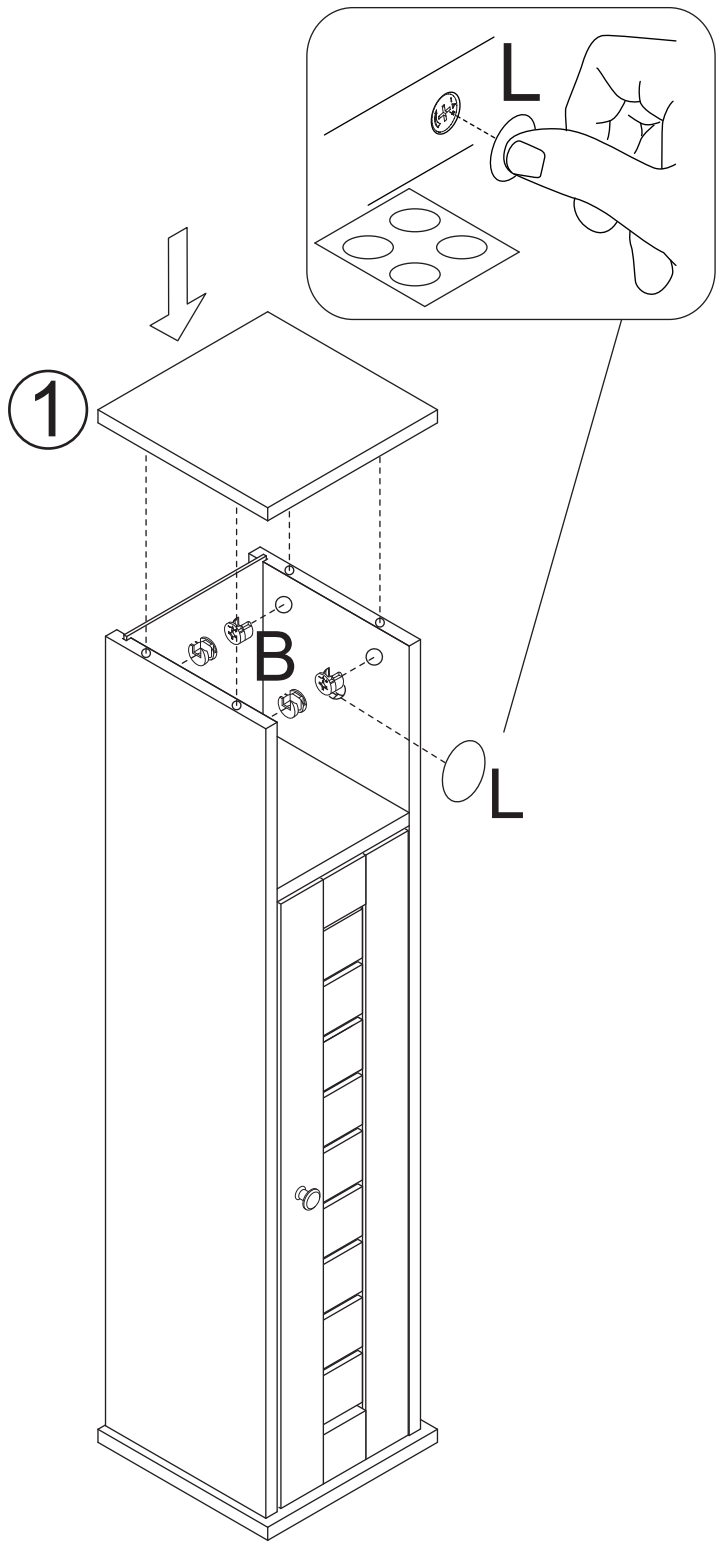
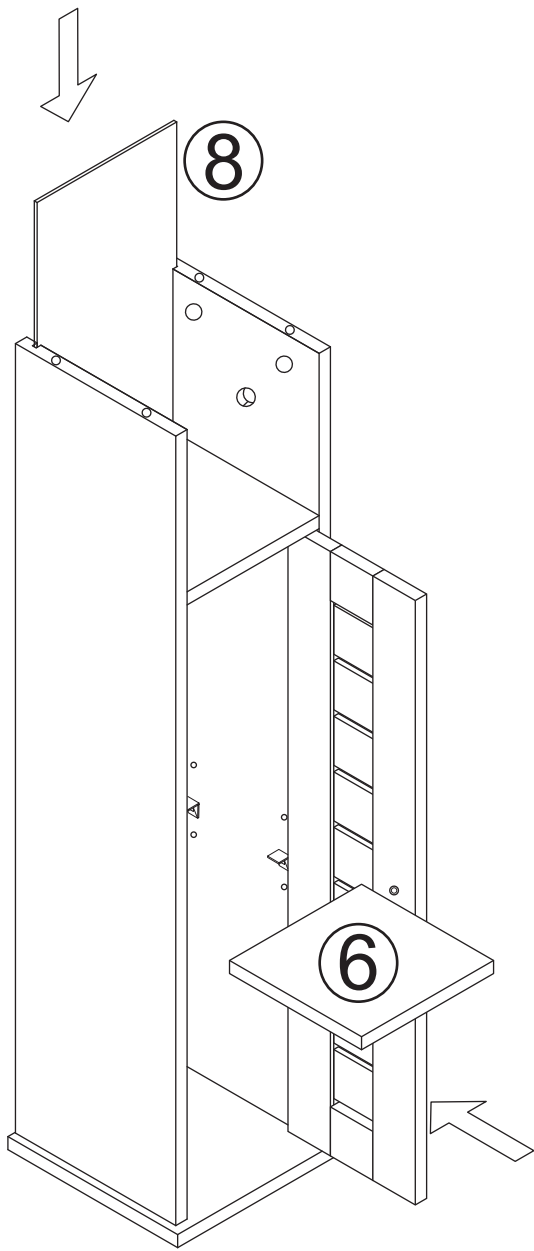

5

FR. Avant de fixer "K", s'assurer que la dimension "XX=YY"

EN. Before fix "K", please make sure size "XX=YY".

PT. Antes de corrigir "K", certifique-se de que o tamanho "XX = YY".

ES. Antes de corregir "K", asegúrese de que el tamaño "XX=YY".

IT. Prima di correggere "K", assicurarsi che la taglia "XX=YY".

DE. Bevor Sie „K“ reparieren, stellen Sie bitte sicher, dass die Größe „XX=YY“ ist.

NL. Voordat u "K" repareert, zorg ervoor dat maat "XX=YY" is.

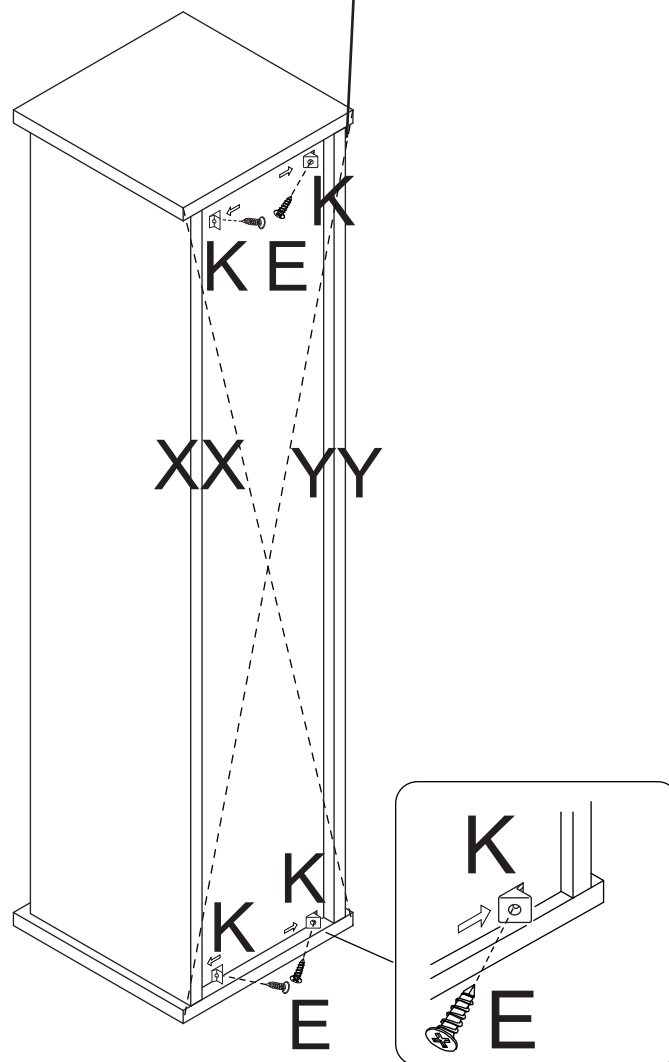

6

