

Assembly Instruction

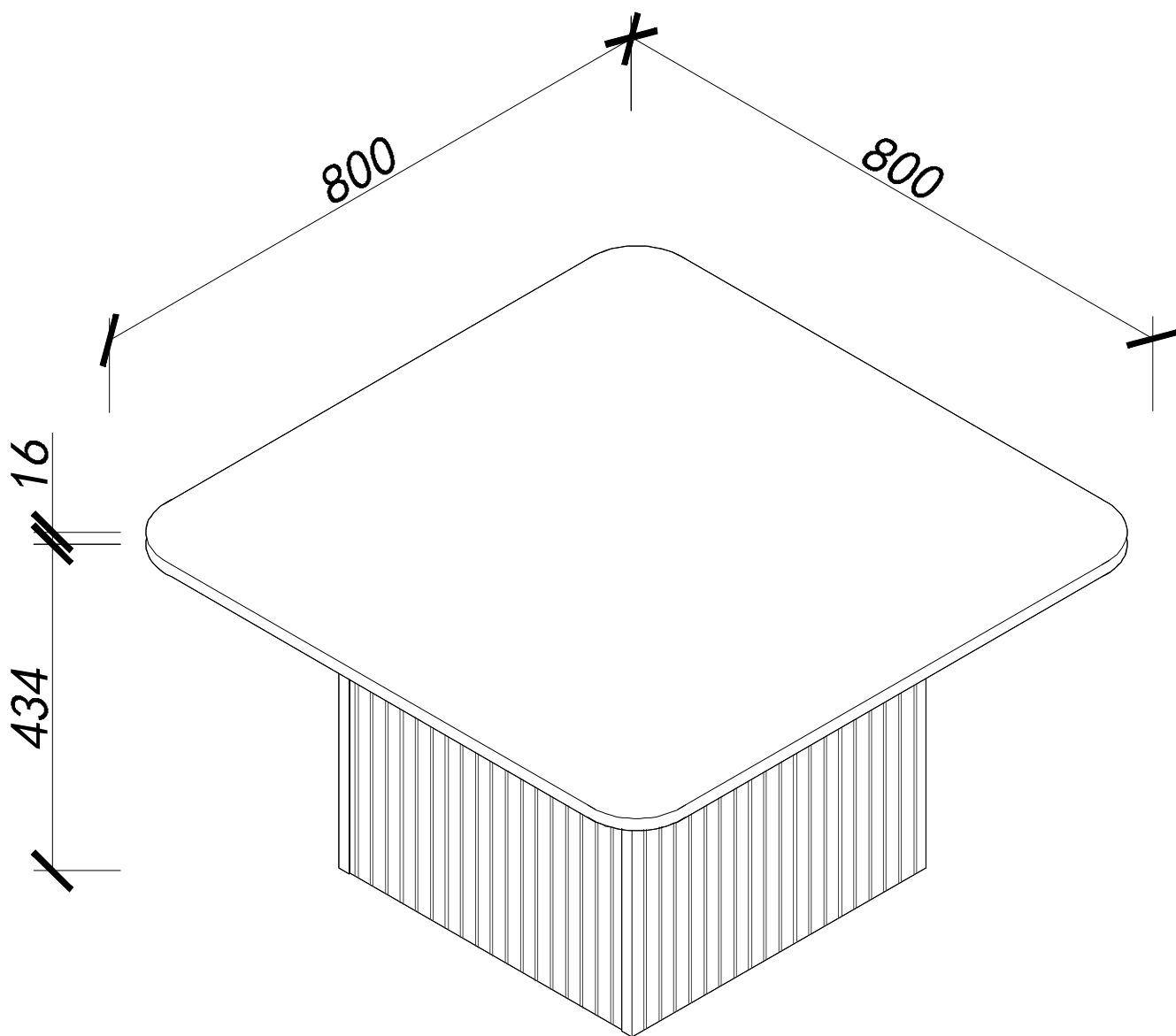

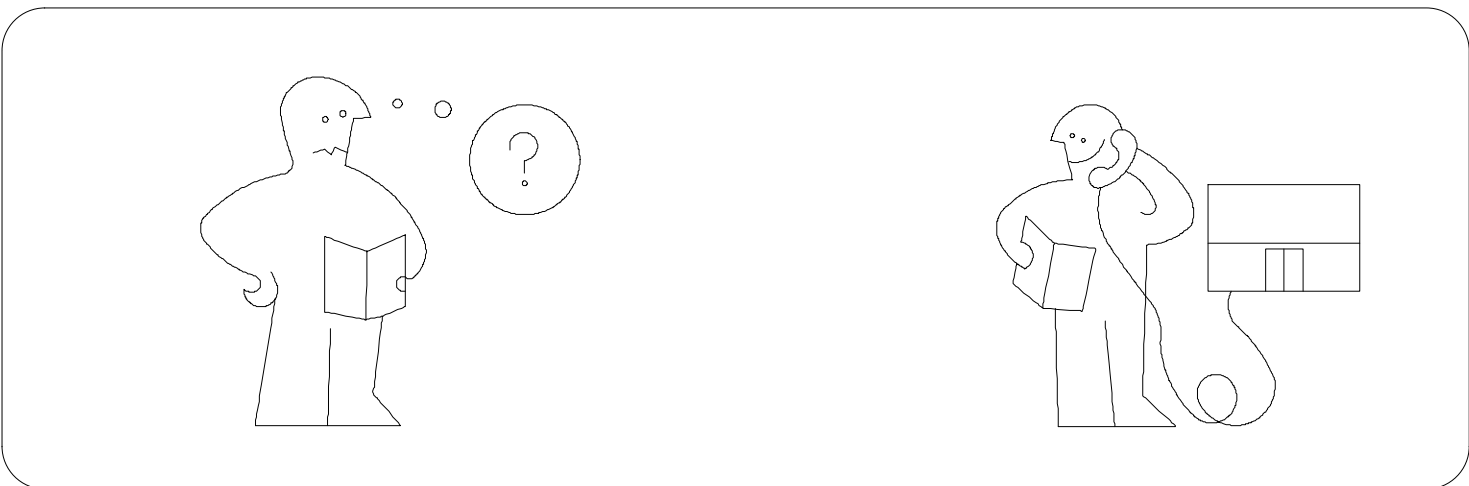

Panel No	Panel Sizes	Quantity
1	800*800*16	1
2	434*450*15	2
3	434*418*15	2

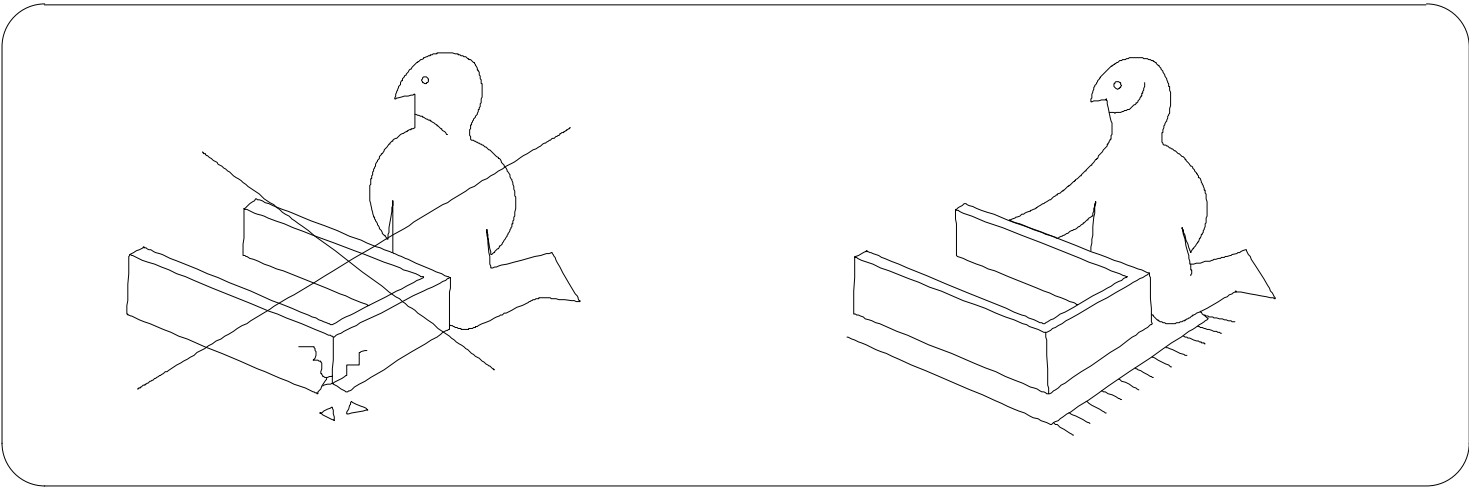
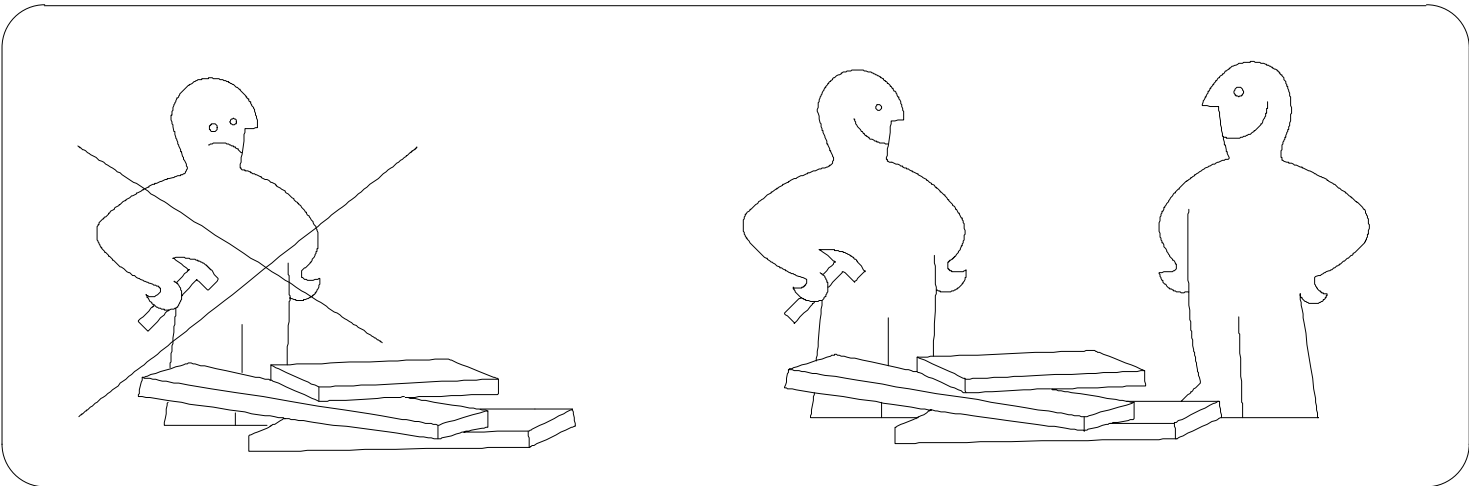
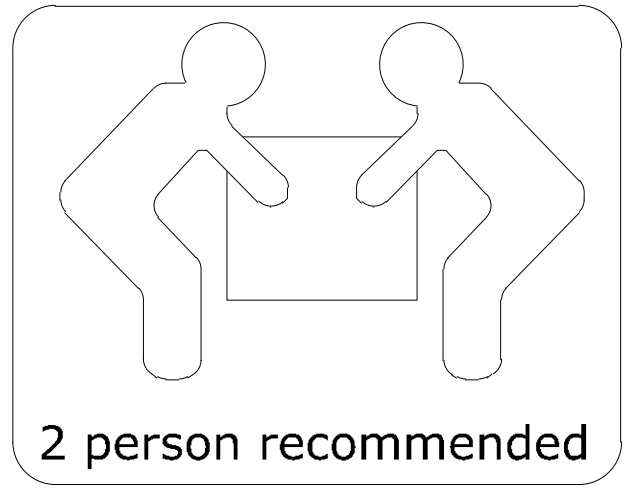
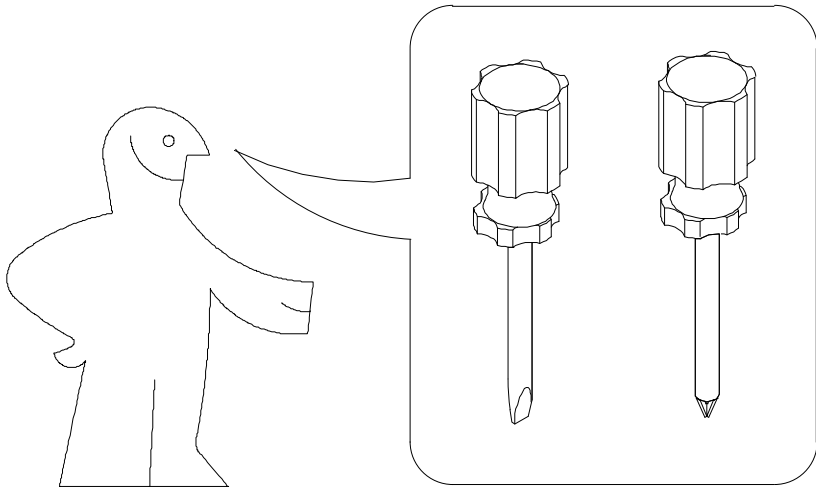
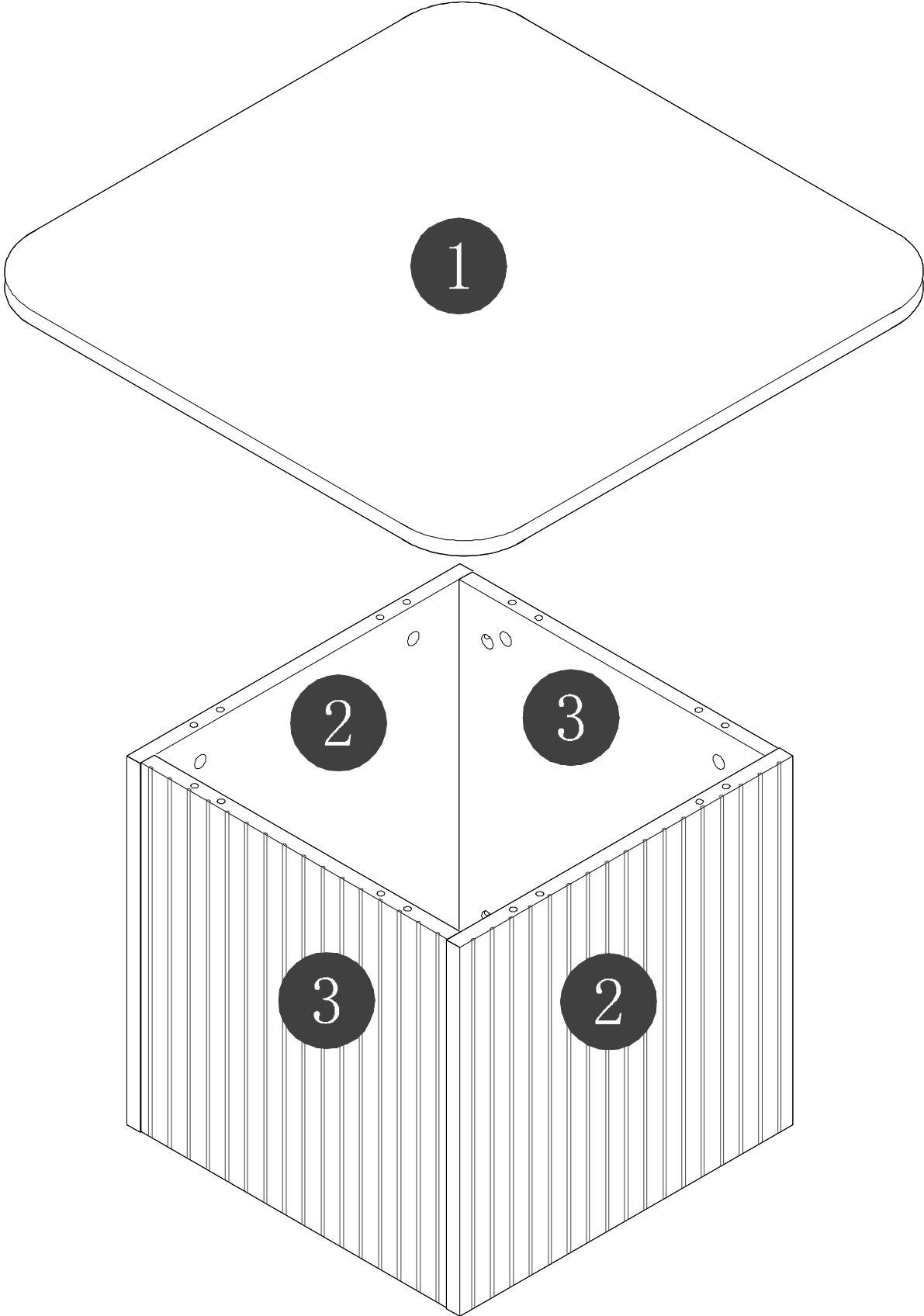

Fittings

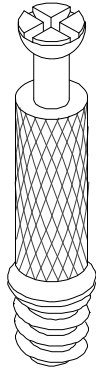

M6*40

A=16



Φ 8*30

B=16

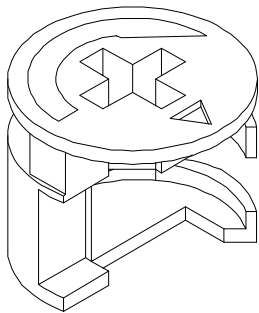

Φ 15*12

C=16



Φ 21

D=16

STEP 1

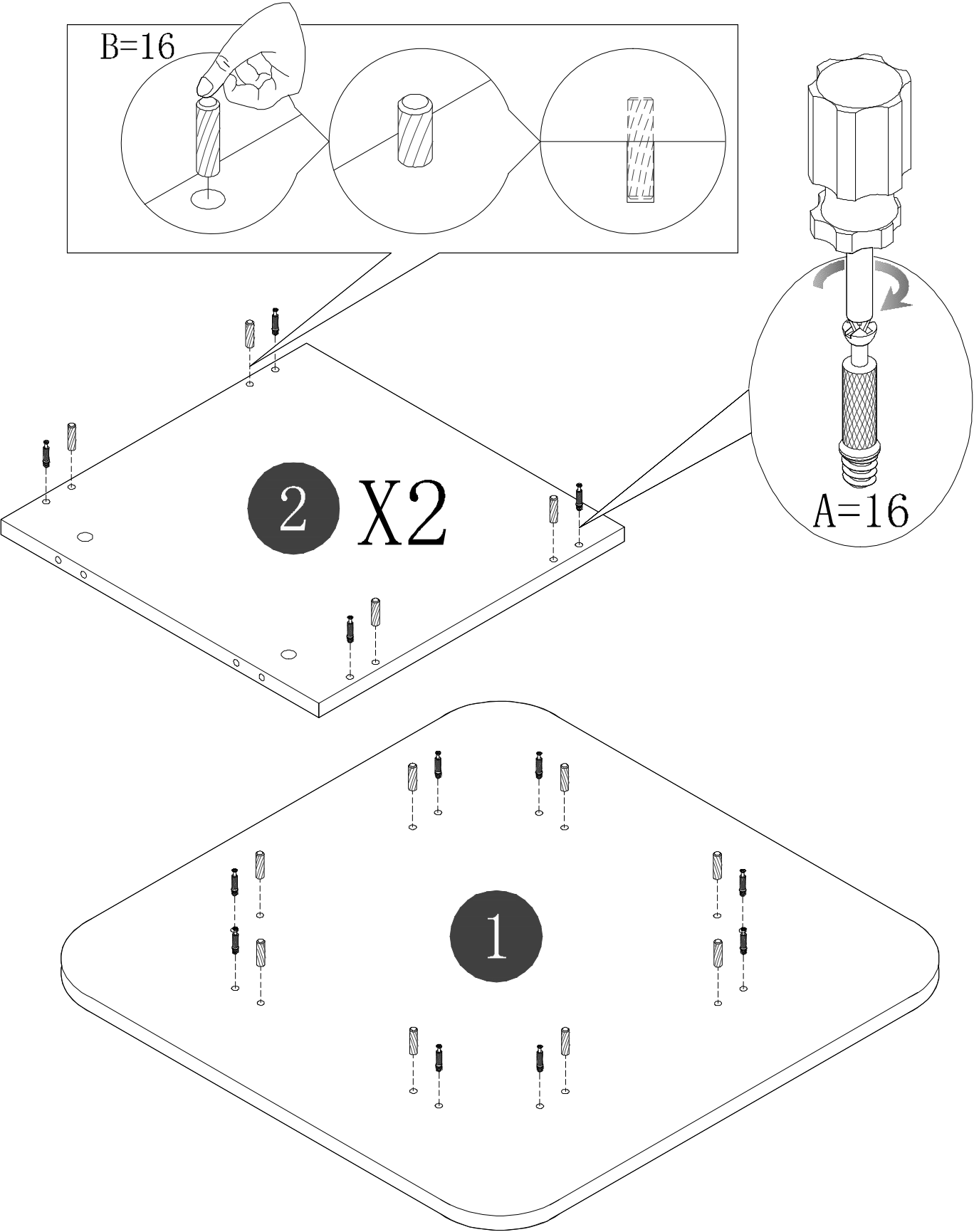

STEP 2

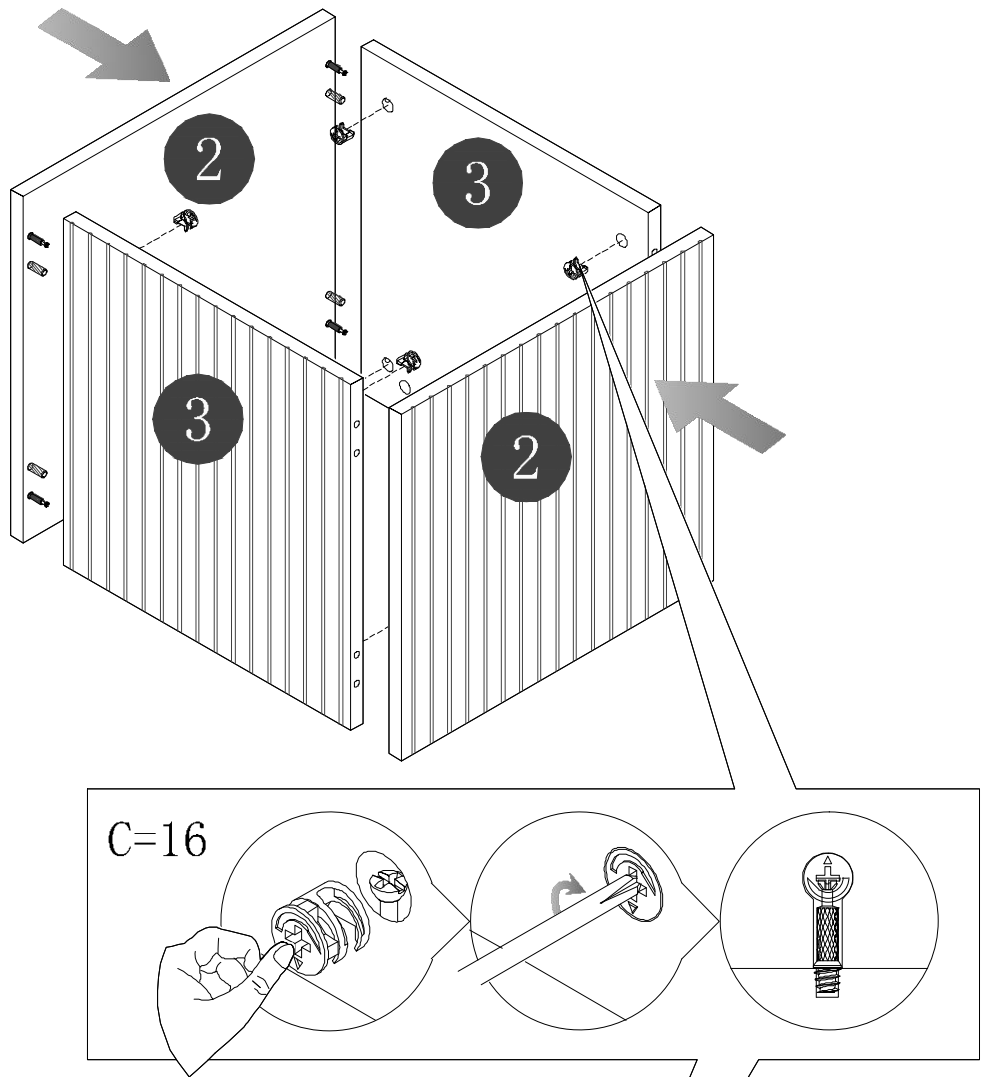

STEP 3

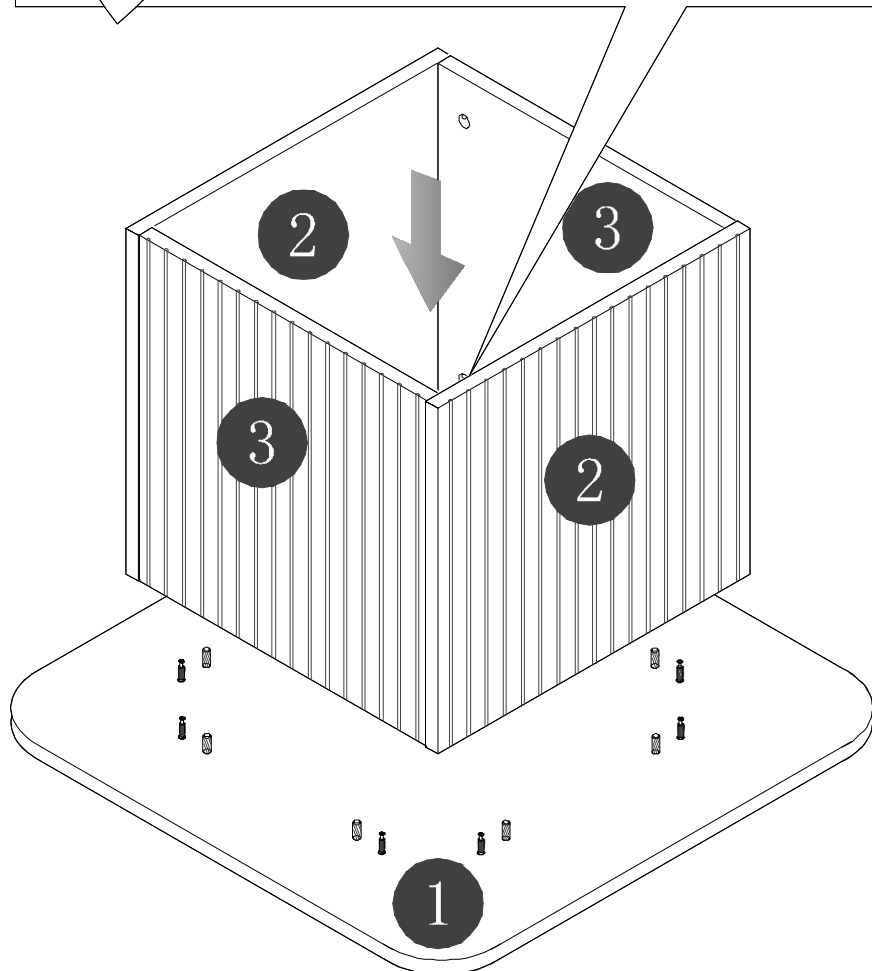

STEP 4

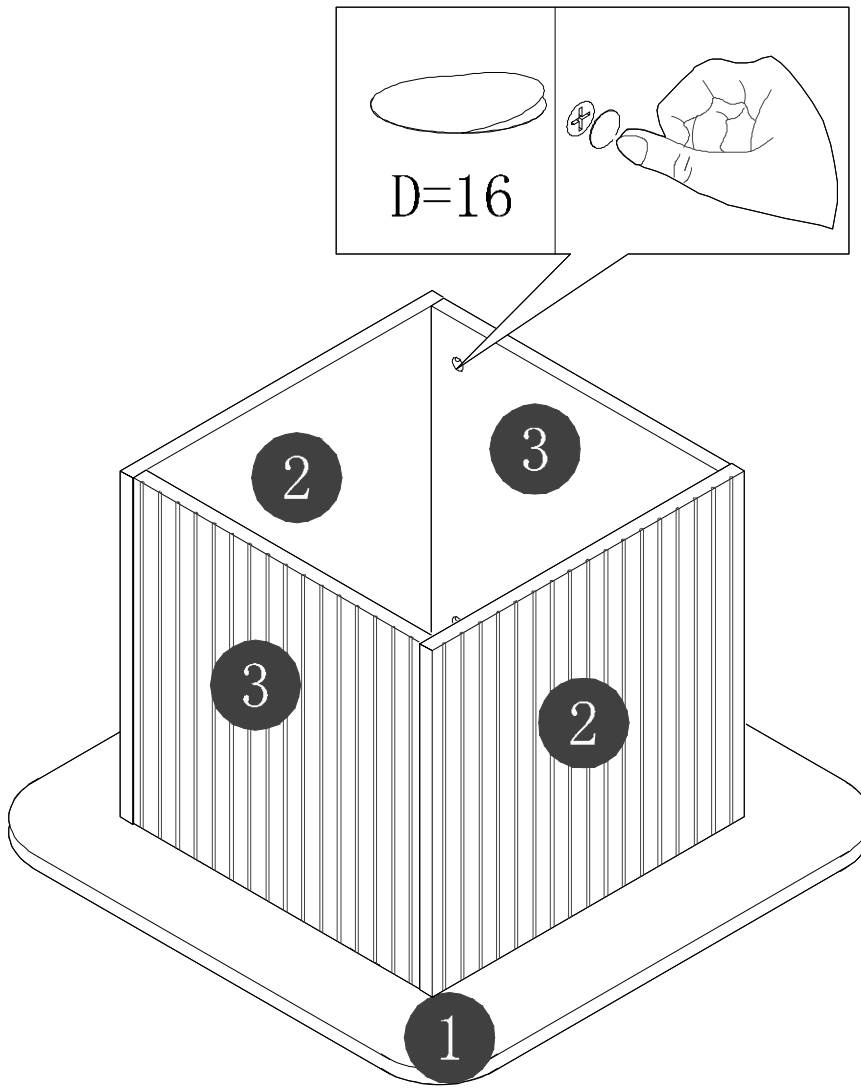

STEP 5

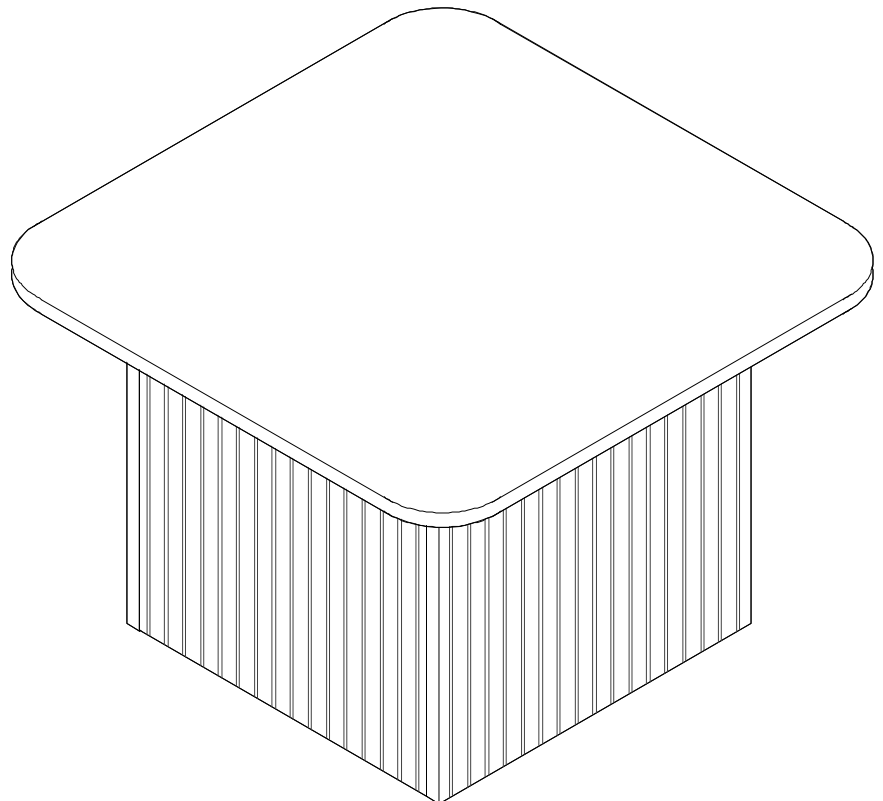

Finish