

Assembly Instruction

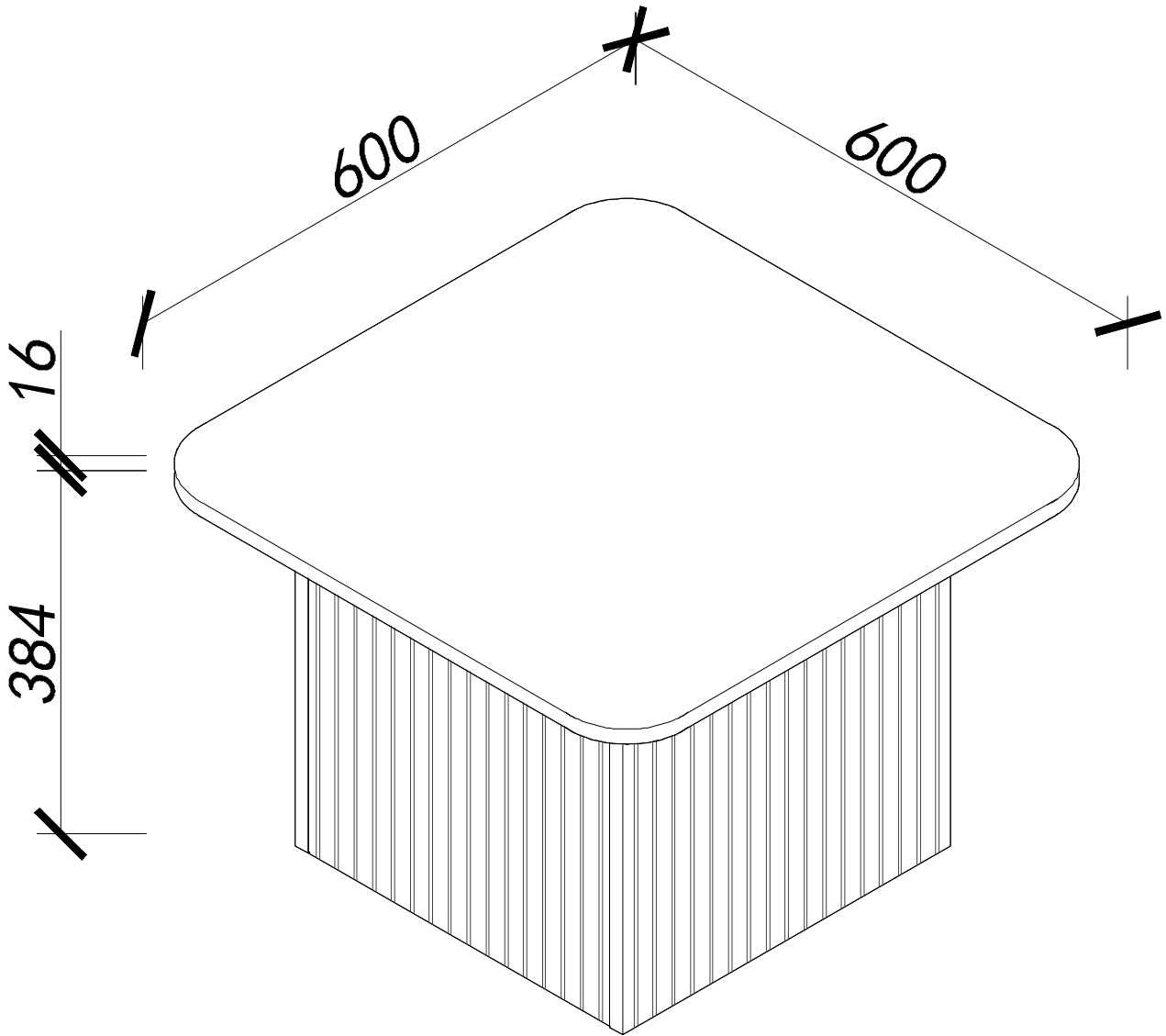

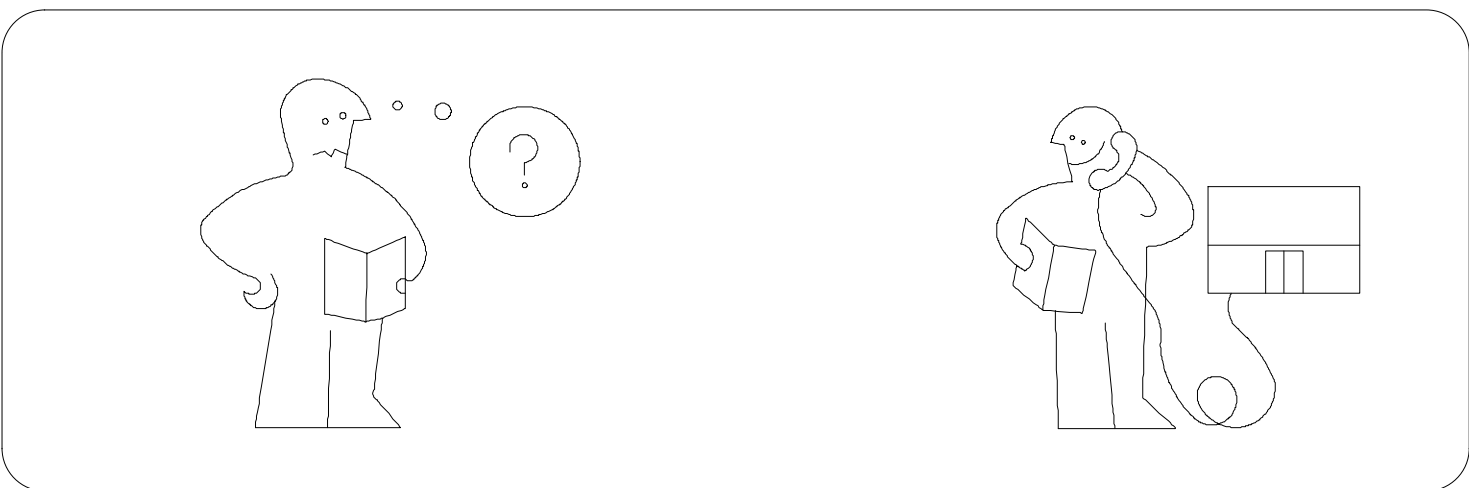

Panel No	Panel Sizes	Quantity
1	600*600*16	1
2	384*400*15	2
3	384*368*15	2

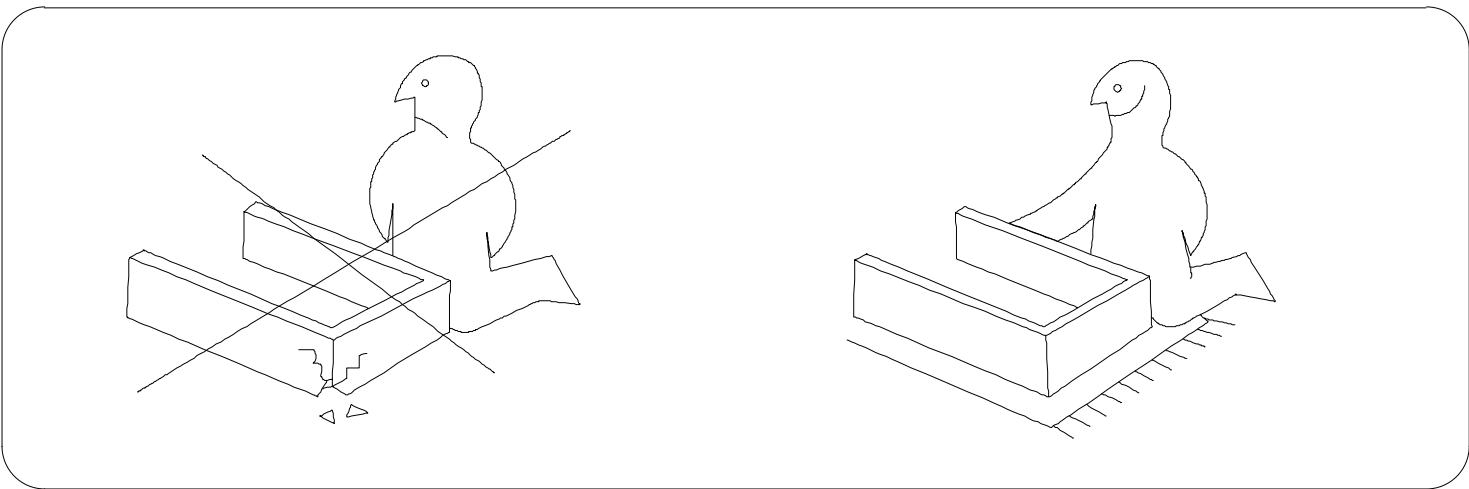
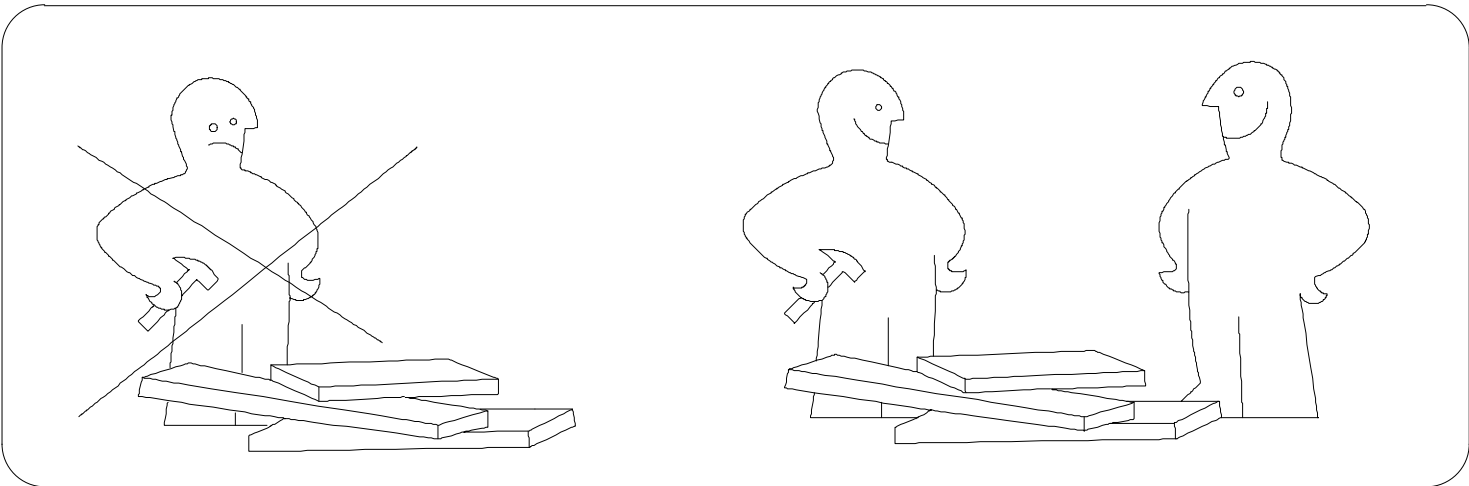
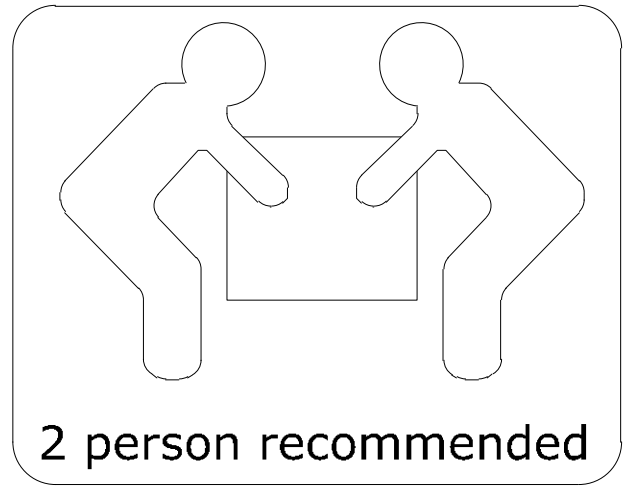
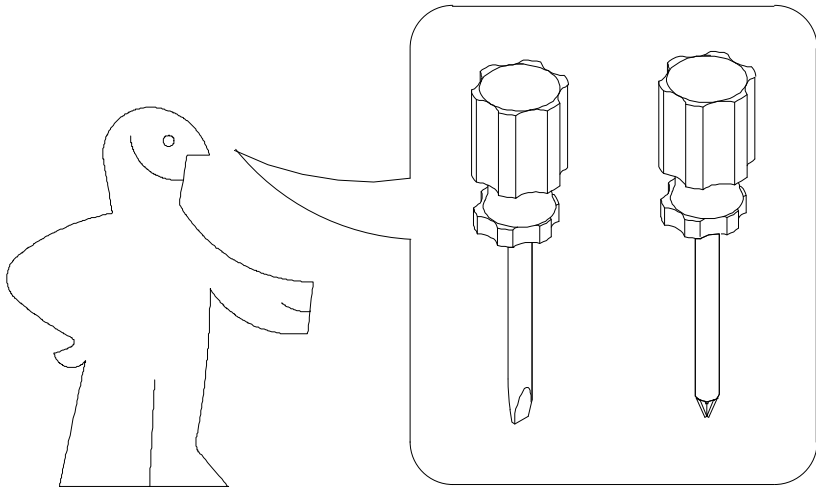
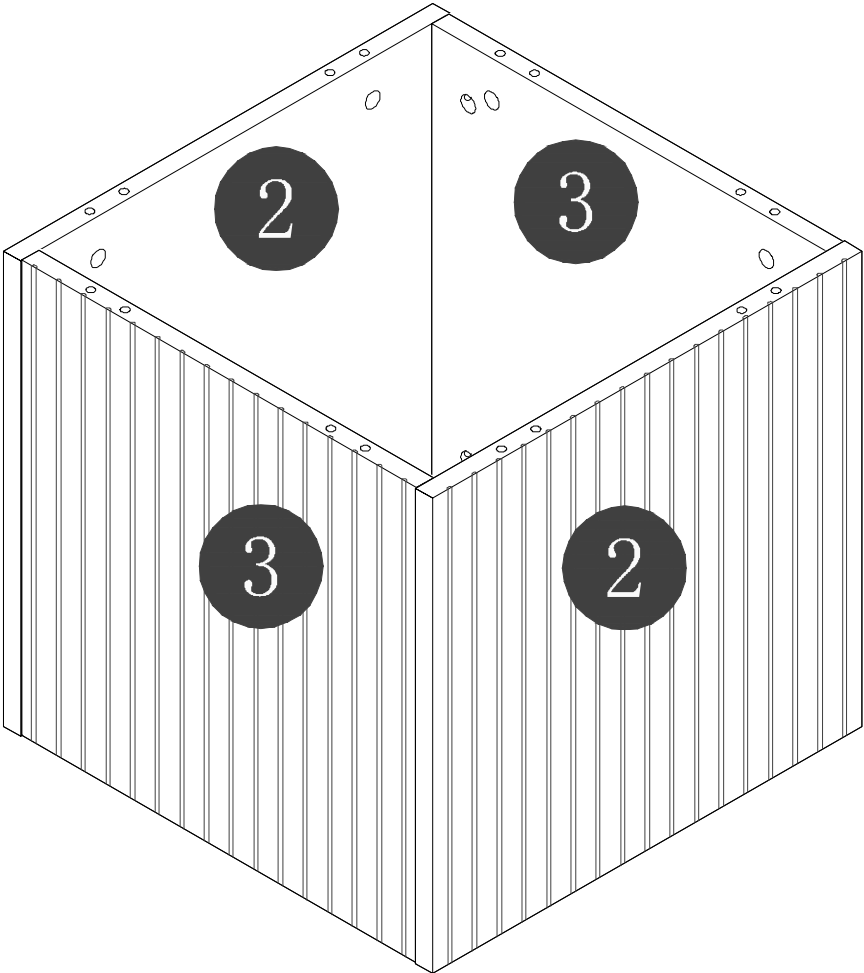
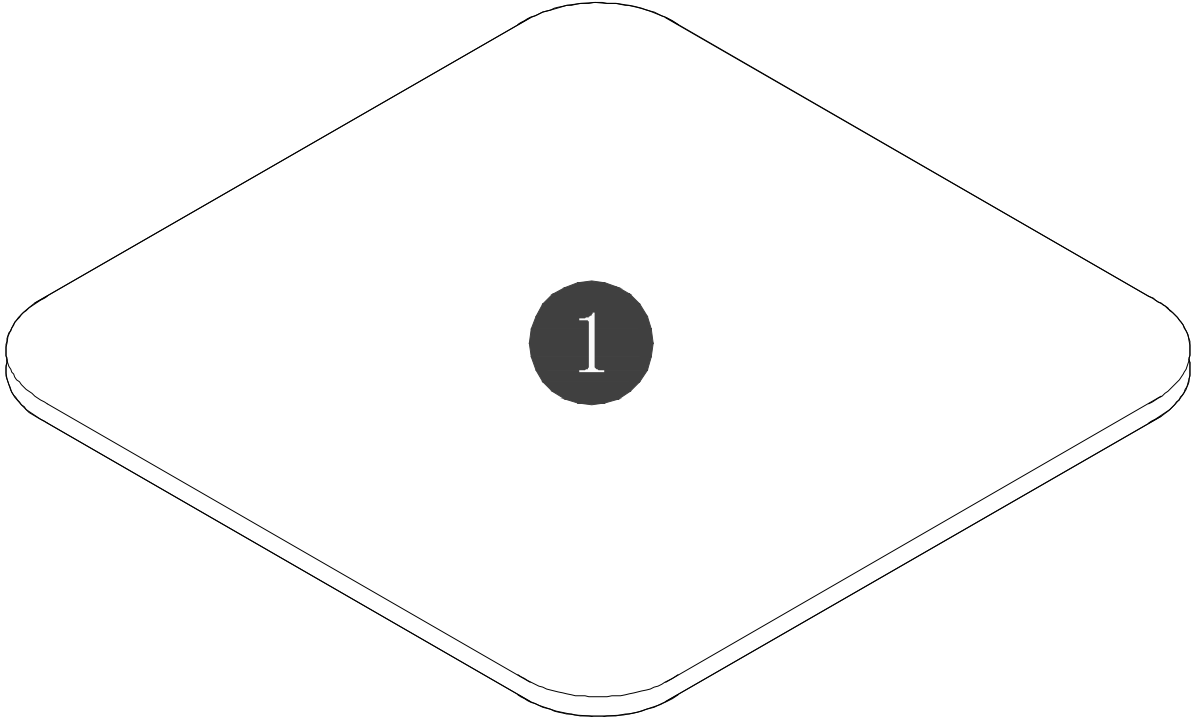

Fittings

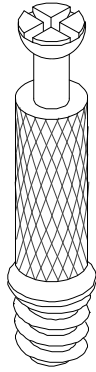

M6*40

A=16



Φ 8*30

B=16

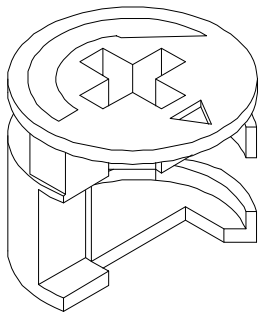

Φ 15*12

C=16



Φ 21

D=16

STEP 1

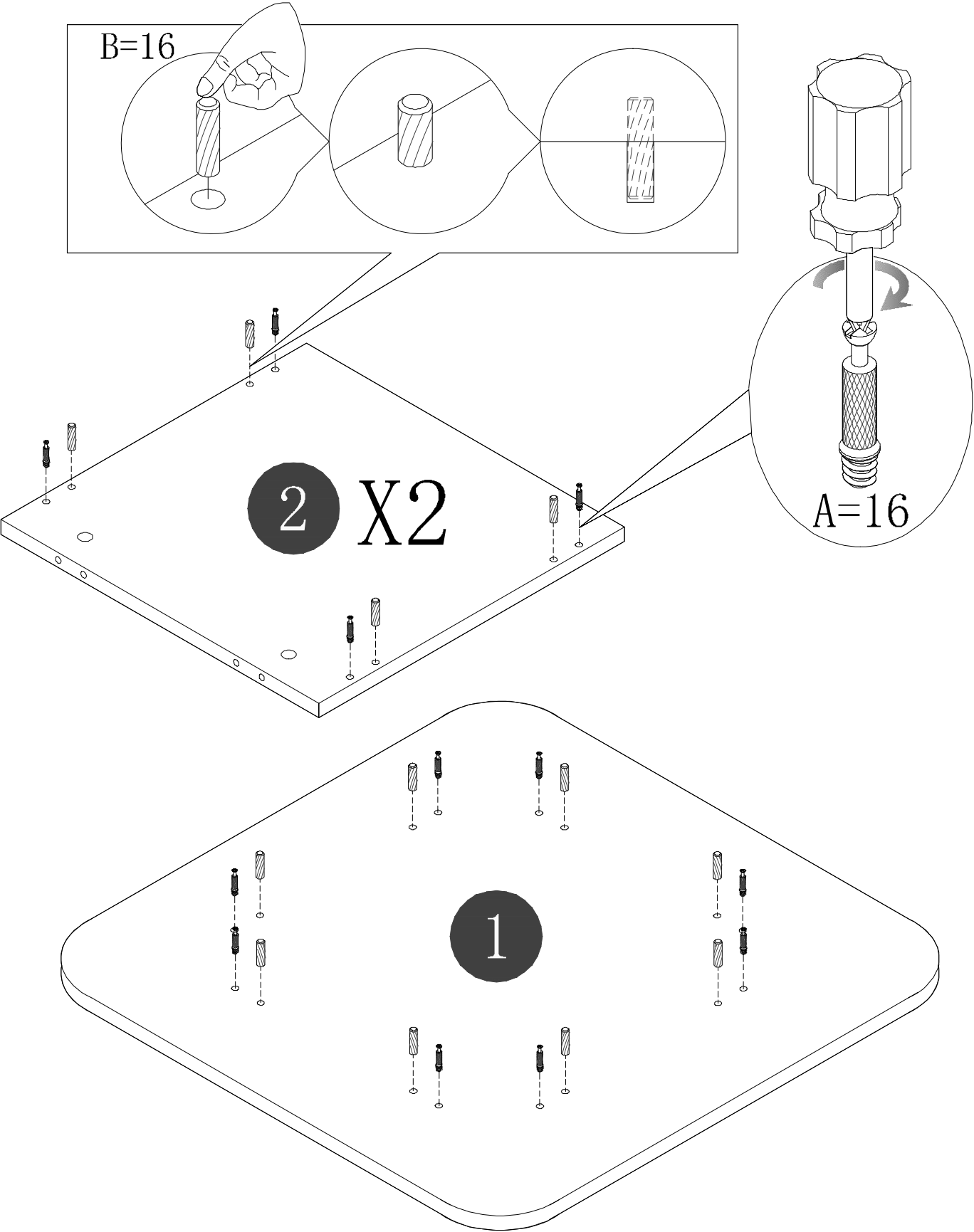

STEP 2

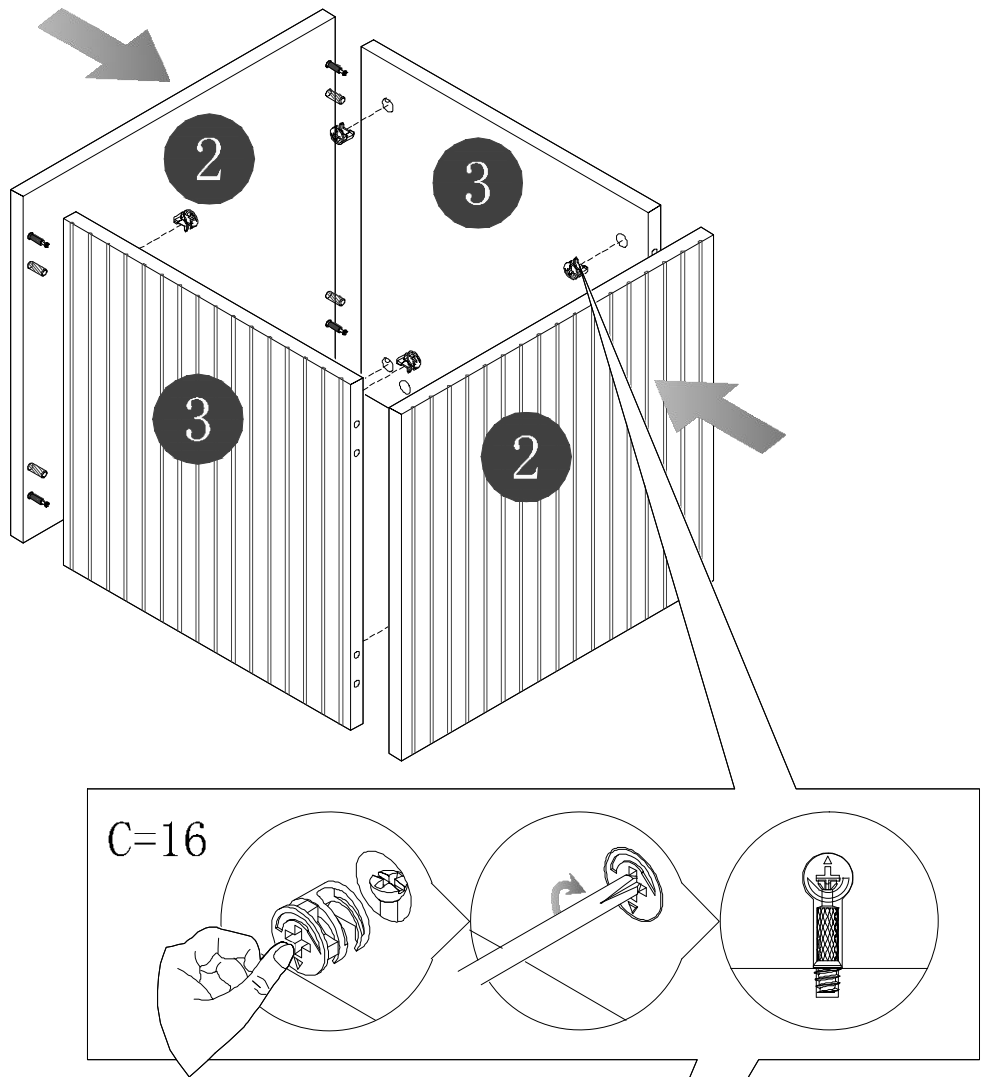

STEP 3

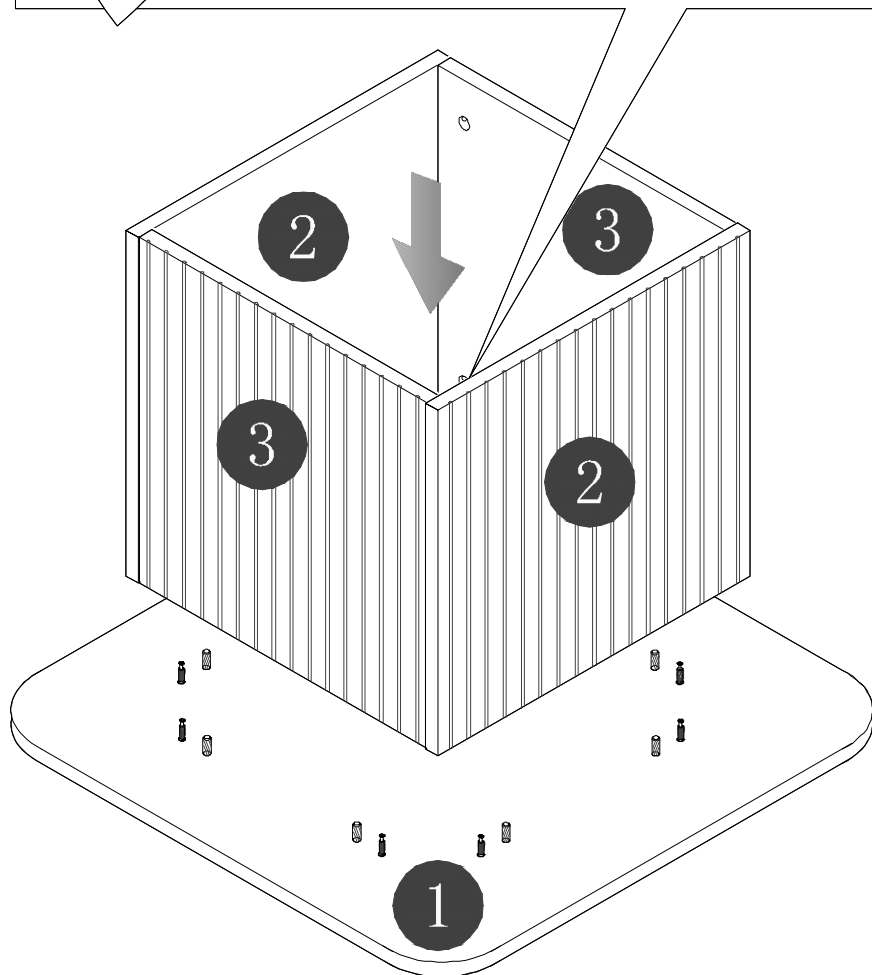

STEP 4

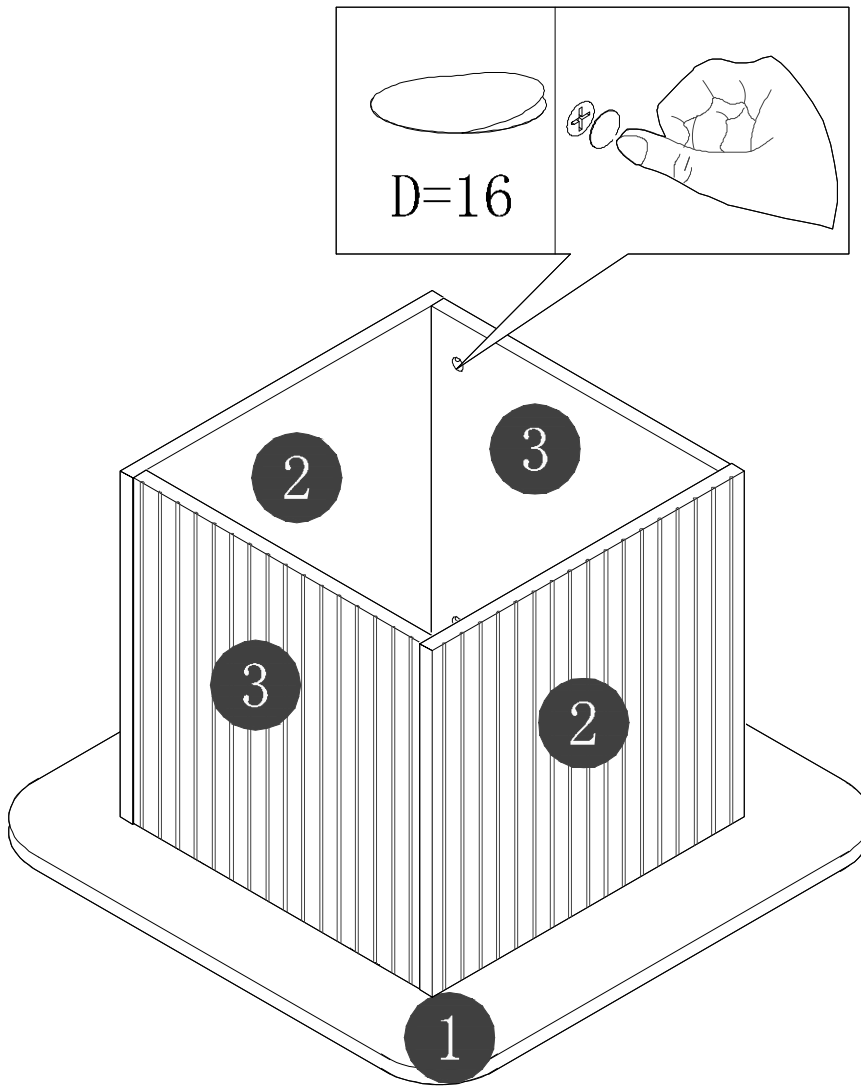

STEP 5

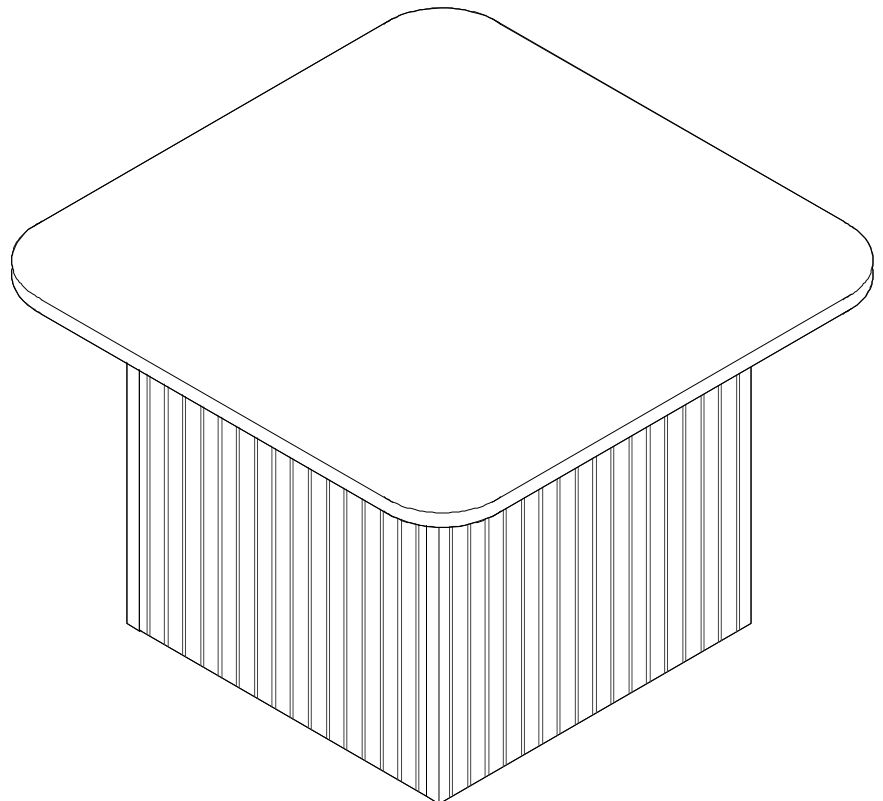

Finish